

REPAIR PARTS MANUAL
MODEL NO. M180HCRD (MI180HCRDE)
Lawn Tractor

 **Electrolux**

HOW TO USE THIS MANUAL

This manual is designed to provide the customer with a means to identify the parts on his/her tractor when ordering repair parts. The illustrations may or may not represent the actual assemblies; therefore, it is not recommended to use this manual as a guide to assemble or disassemble the tractor. Some hardware and parts are drawn larger in order to more readily identify them.

Each tractor has its own model number.

The model number for your tractor can be found on the fender under the seat.

When ordering parts, always give the following information:

- Product - "Tractor"
- Model Number - "M180HCRD (MI180HCRDE)"
- Part Number
- Part Description

TABLE OF CONTENTS

SCHEMATIC	3
ELECTRICAL	4-5
CHASSIS	6-7
DRIVE	8-9
STEERING	10-11
SEAT	12
DECALS	13
ENGINE	14-15
MOWER LIFT	16-17
MOWER DECK	18-19
BAGGER	20-21

TRACTOR- -MODEL NO. M180HCRD (MI180HCRDE), PRODUCT NO. 964 77 29-00
SCHEMATIC

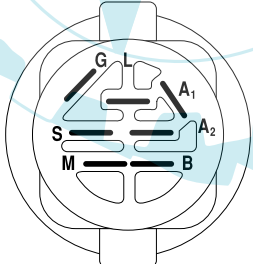
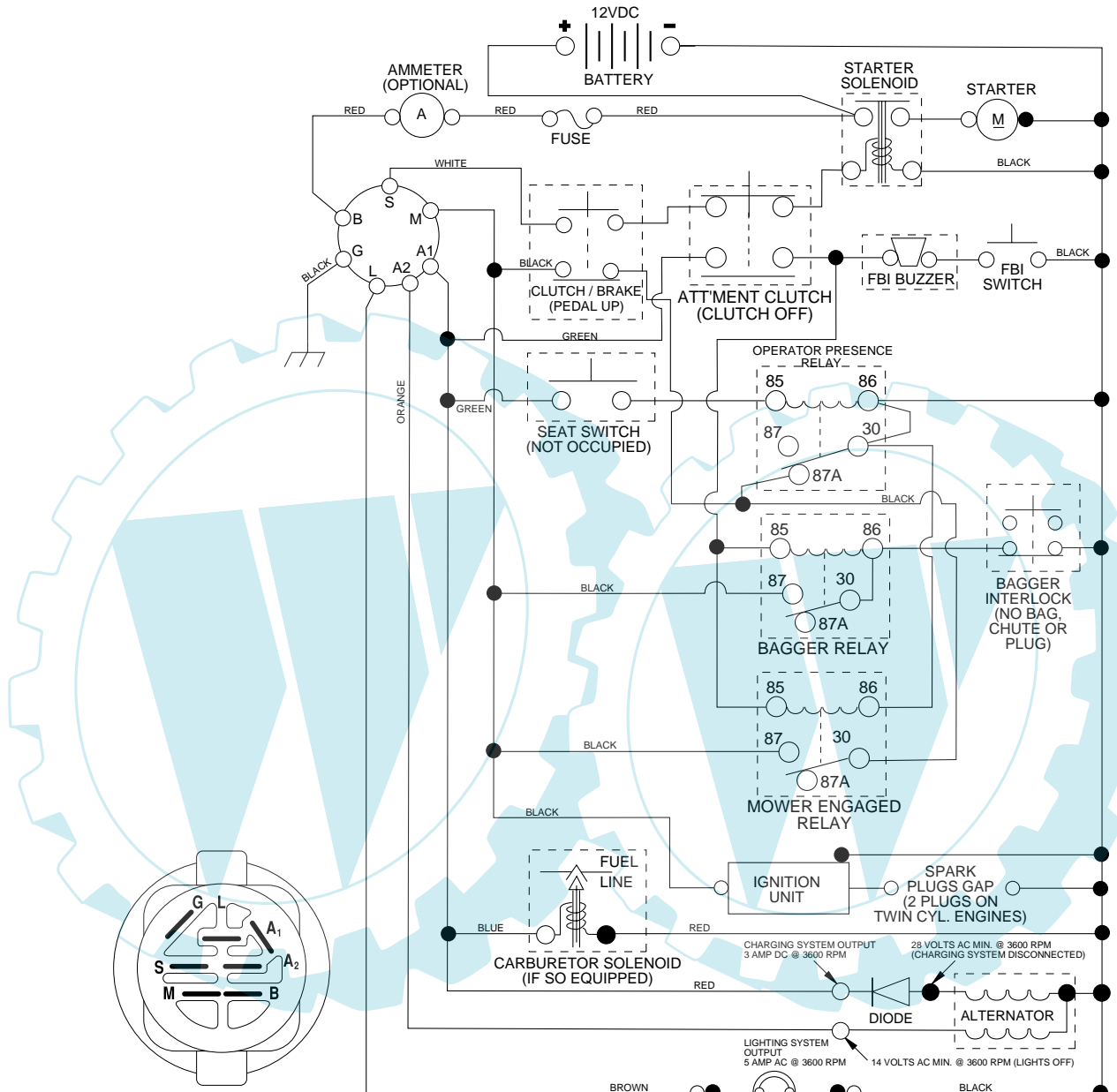

IGNITION SWITCH

POSITION	CIRCUIT	"MAKE"
OFF	M+G+A1	NONE
RUN/LIGHT	B+A1	A2+L
RUN	B+A1	NONE
START	B + S + A1	NONE

WIRING INSULATED CLIPS
NOTE: IF WIRING INSULATED CLIPS WERE REMOVED FOR SERVICING OF UNIT, THEY SHOULD BE REPLACED TO PROPERLY SECURE YOUR WIRING.

● NON-REMOVABLE CONNECTIONS

○ REMOVABLE CONNECTIONS

PTO SWITCH

POSITION	CIRCUIT
OFF	C + G, B + H
ON	C + F, B + E, A + D

NOTE
YOUR TRACTOR IS EQUIPPED WITH A SPECIAL ALTERNATOR SYSTEM. THE LIGHTS ARE NOT CONNECTED TO THE BATTERY, BUT HAVE THEIR OWN ELECTRICAL SOURCE. BECAUSE OF THIS, THE BRIGHTNESS OF THE LIGHTS WILL CHANGE WITH ENGINE SPEED. AT IDLE THE LIGHTS WILL DIM. AS THE ENGINE IS SPEEDED UP, THE LIGHTS WILL BECOME THEIR BRIGHTEST.

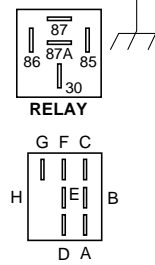

REPAIR PARTS

TRACTOR- -MODEL NO. M180HCRD (MI180HCRDE), PRODUCT NO. 964 77 29-00
ELECTRICAL

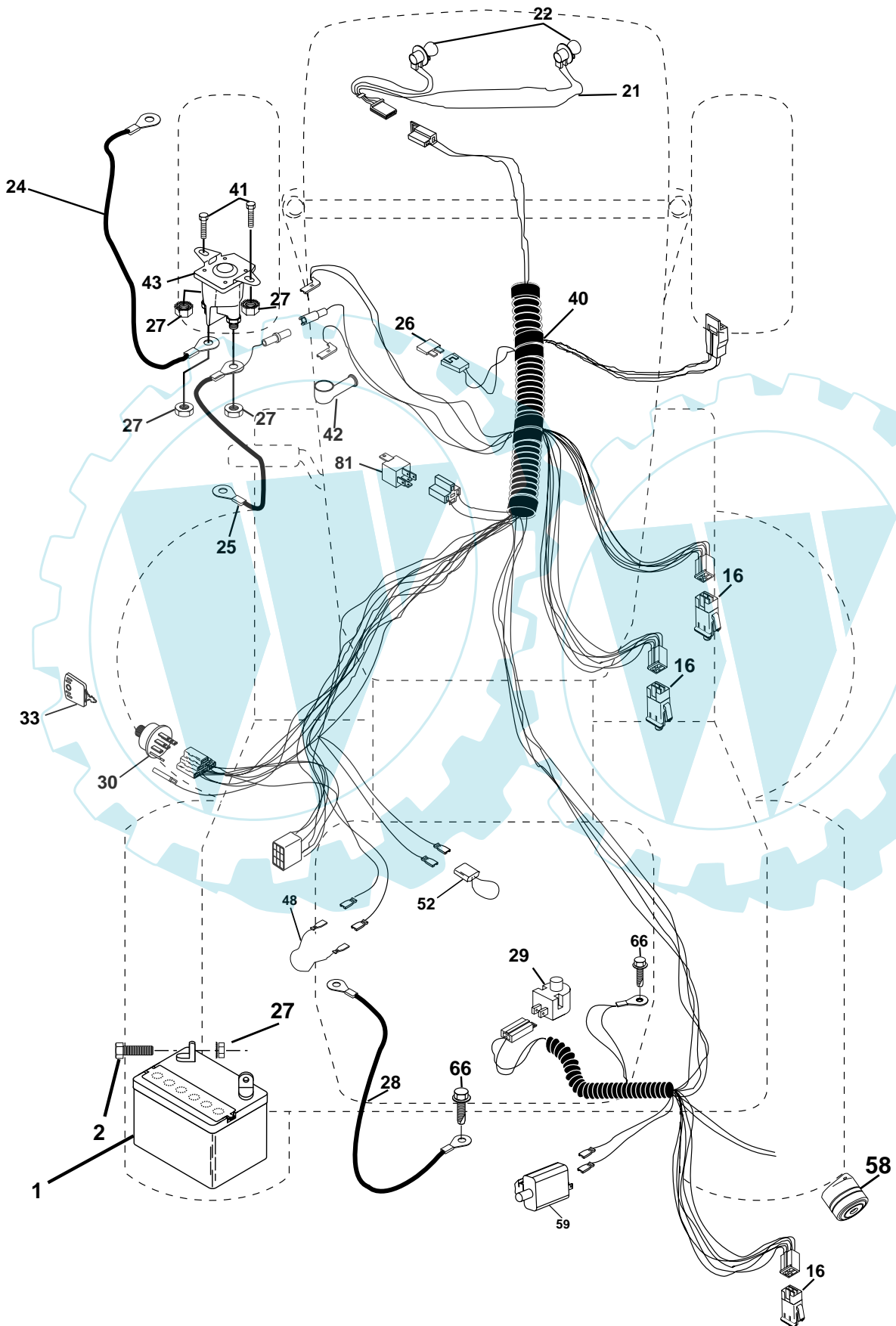

REPAIR PARTS

TRACTOR- -MODEL NO. M180HCRD (M180HCRDE), PRODUCT NO. 964 77 29-00
ELECTRICAL

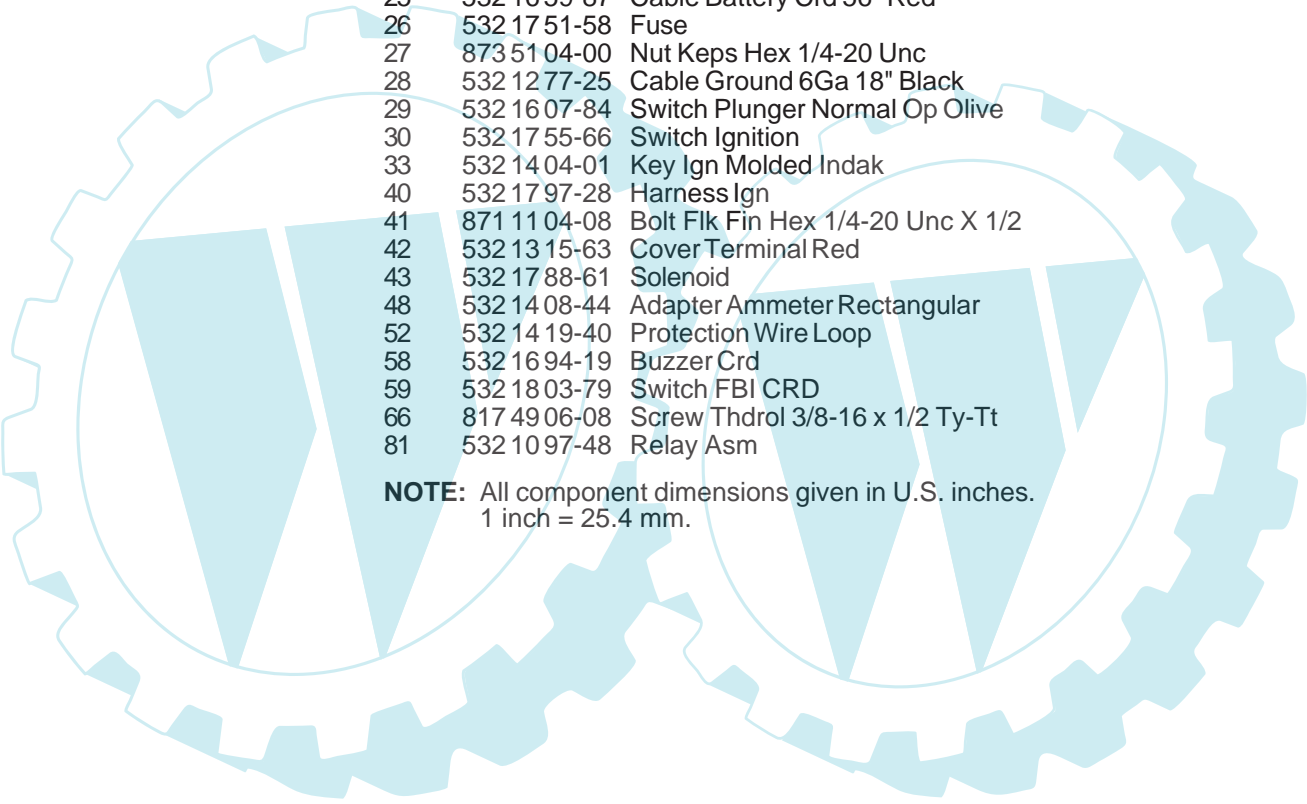

KEY NO.	PART NO.	DESCRIPTION
1	532 14 49-27	Battery
2	874 76 04-12	Bolt Hex Hd 1/4-20 Unc X 3/4
16	532 17 61-38	Switch Interlock
21	532 17 56-85	Harness Asm Light W/4152J
22	532 00 41-52	Bulb Light #1156
24	532 12 47-80	Cable Starter 6Ga 11" Red
25	532 16 59-87	Cable Battery Crd 56" Red
26	532 17 51-58	Fuse
27	873 51 04-00	Nut Keps Hex 1/4-20 Unc
28	532 12 77-25	Cable Ground 6Ga 18" Black
29	532 16 07-84	Switch Plunger Normal Op Olive
30	532 17 55-66	Switch Ignition
33	532 14 04-01	Key Ign Molded Indak
40	532 17 97-28	Harness Ign
41	871 11 04-08	Bolt Flk Fin Hex 1/4-20 Unc X 1/2
42	532 13 15-63	Cover Terminal Red
43	532 17 88-61	Solenoid
48	532 14 08-44	Adapter Ammeter Rectangular
52	532 14 19-40	Protection Wire Loop
58	532 16 94-19	Buzzer Crd
59	532 18 03-79	Switch FBI CRD
66	817 49 06-08	Screw Thdrol 3/8-16 x 1/2 Ty-Tt
81	532 10 97-48	Relay Asm

NOTE: All component dimensions given in U.S. inches.
1 inch = 25.4 mm.

REPAIR PARTS

TRACTOR- -MODEL NO. M180HCRD (MI180HCRDE), PRODUCT NO. 964 77 29-00
CHASSIS AND ENCLOSURES

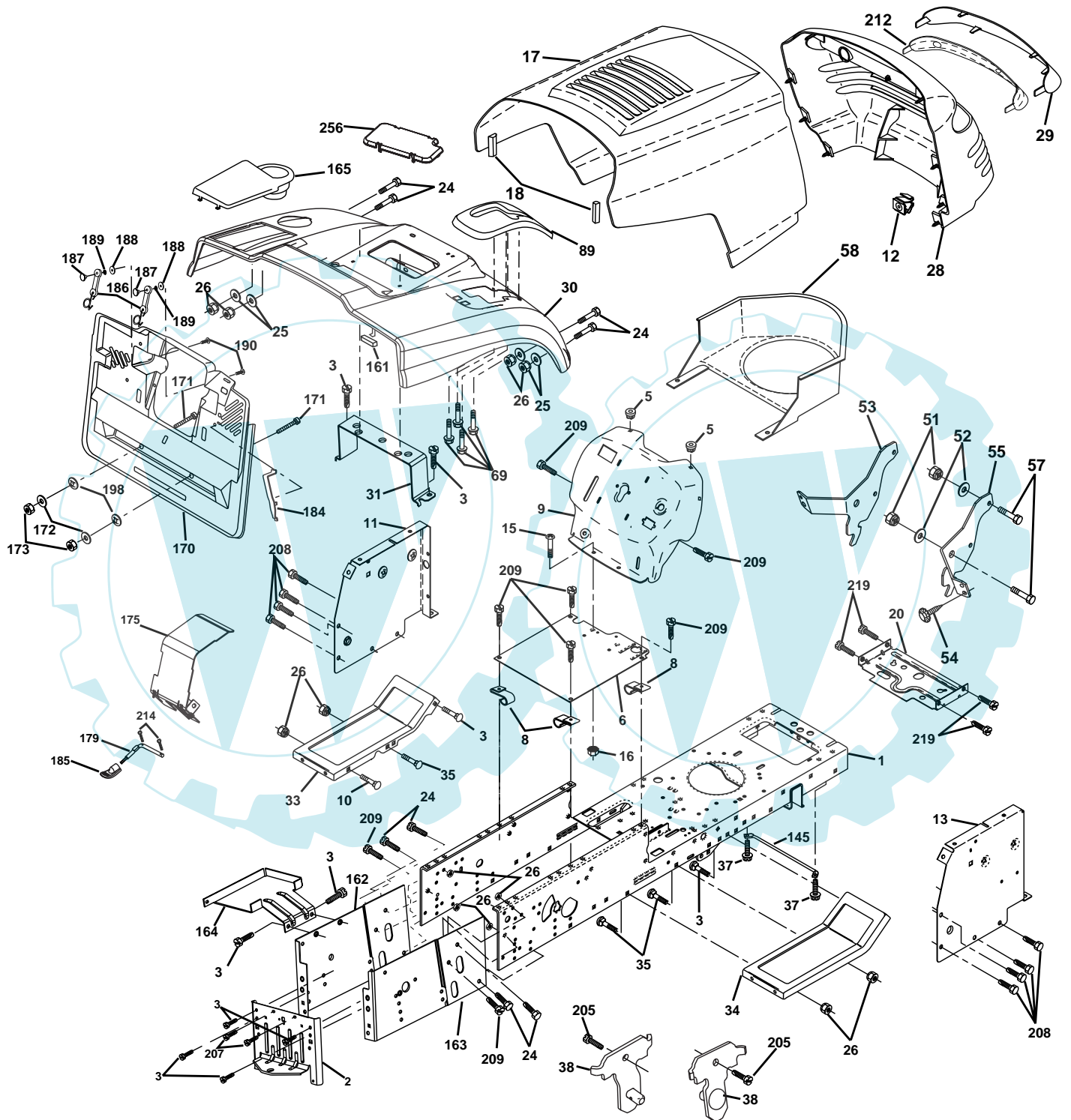

REPAIR PARTS

TRACTOR- -MODEL NO. M180HCRD (M180HCRDE), PRODUCT NO. 964 77 29-00 CHASSIS AND ENCLOSURES

KEY NO.	PART NO.	DESCRIPTION	KEY NO.	PART NO.	DESCRIPTION
1	532 17 46-20	Chassis	57	874 78 04-12	Bolt, Fin Hex 1/4-20 UNC x .75
2	532 18 03-84	Drawbar	58	532 17 49-30	Duct Air Engine Pl/Lt
3	817 06 06-12	Screw 3/8-16 x .75	69	532 14 24-32	Screw Hex 1/4-1/2
5	532 15 52-72	Bumper Hood/Dash	89	532 18 13-60	Console
6	532 15 59-23	Saddle	145	532 15 65-24	Rod Pivot Chassis/Hood
8	532 12 64-71	Clip Insulator 13/32 Mtg. Hole	162	532 18 03-82	Bracket Exten Chassis Lh CRD
9	532 17 22-43	Dash	163	532 18 03-83	Bracket Exten Chassis Rh CRD
10	872 14 06-08	Bolt, Carriage 3/8-16 x 3/4	164	532 16 56-05	Support Battery CRD
11	532 17 49-96	Panel, Dash, L.H.	165	532 18 13-56	Cover Battery CRD Lt
12	532 14 56-60	Clip Tinnerman Grille P/L	170	532 17 88-62	Backplate Asm CRD
13	532 18 17-19	Panel, Asm. Dash R.H.	171	872 14 06-20	Bolt Rdhd Sqnk 3/8-16 x 2-1/2 G5
15	874 18 05-12	Screw, Machine, Truss Head 5/16-18 UNC x 3/4	172	819 13 20-16	Washer 13/32 x 1-1/4 x 16 Ga.
16	873 51 05-00	Nut	173	873 51 06-00	Nut, Keps Hex 3/8-16 UNC
17	532 16 03-82	Hood Assembly	175	532 18 03-10	Trap Door CRD
18	532 12 69-38	Bumper Hood	179	532 18 03-76	Rod Pivot FBI CRD
20	532 18 06-79	Plate Mtg. Battery/Fuel Tank	184	532 17 46-62	Bracket Actuator Bagger CRD
24	874 78 06-16	Bolt	185	532 18 11-01	Knob Rod
25	819 13 13-12	Washer 13/32 x 13/16 x 12 Gauge	186	532 16 07-93	Latch Asm Multch Bagger
26	873 80 06-00	Nut	187	532 12 50-04	Nut Weld .327/.304 #10-24
28	532 17 91-00	Grille Lens Asm	188	819 06 12-16	Washer #10
29	532 16 81-54	Lens	189	810 07 10-00	Washer Lock #10
30	532 18 13-86	Fender	190	871 08 10-10	Screw Pan Hd Phillips 10-24 x 5/8
31	532 16 51-56	Bracket, Fender Support	198	532 16 89-37	Nut Push
33	532 18 10-57	Footrest, L.H.	205	817 49 06-08	Screw 3/8-16 x 1/2
34	532 18 10-58	Footrest, R.H.	208	817 67 06-08	Screw Thdrol 3/8-16 x 1/2
35	872 11 06-06	Bolt	209	817 00 06-12	Screw Hex Wsh Thdrol 3/8-16 x 3/4
37	817 49 05-08	Screw Thdrol 5/16-18 x 1/2 TYT	212	532 15 62-29	Insert Lens Reflective
38	532 18 17-48	Bracket Asm Pivot Mower Rear	214	532 12 47-88	Retainer Spring 1"
51	873 80 04-00	Nut Lock w/Insert 1/4-20 UNC	215	817 06 05-08	Screw 5/16-18 x 1/2
52	819 09 14-16	Washer 9/32 x 7/8 x 16 Ga.	219	817 00 05-12	Screw 5/16-18 x 3/4
53	532 14 46-97	Bracket Grille Lh	256	532 18 13-61	Cover Fender Rack CRD
54	532 16 14-64	Screw Hex Wshd 8-18 x 7/8	--	532 00 54-79	Plug, Button
55	532 14 46-96	Bracket Grille Rh			

NOTE: All component dimensions given in U.S. inches.
1 inch = 25.4 mm.

REPAIR PARTS

TRACTOR- -MODEL NO. M180HCRD (MI180HCRDE), PRODUCT NO. 964 77 29-00
DRIVE



REPAIR PARTS

TRACTOR- -MODEL NO. M180HCRD (M180HCRDE), PRODUCT NO. 964 77 29-00 DRIVE

KEY NO.	PART NO.	DESCRIPTION	KEY NO.	PART NO.	DESCRIPTION
1	-----	Transaxle Hydro Gear 321-0510 (Order parts from transaxle manufacturer)	145	874 49 05-44	Bolt Hex FGHD 5/16-18 x Gr 5
8	532 16 56-19	Rod, Shift Fender Adjust Lt	150	532 16 58-50	Bushing, Bellcrank Grnd Dr
9	532 18 03-54	Clutch Noram	151	819 13 32-10	Washer 13/32 x 2 x 10 Ga.
10	876 02 04-16	Pin, Cotter 1/8 x 1	156	532 16 60-02	Washer Srrted 5/16ID x 1.125
14	810 04 04-00	Washer, Lock Hvy Helical	158	532 16 55-89	Bracket Shift Mount
16	873 80 05-00	Nut, Lock Hex W/Ins 5/16-18 UNC	159	532 16 54-94	Hub Tapered Flange Shift Lt
21	532 10 69-33	Knob	160	819 29 20-16	Washer 29/32 x 1-1/4 x 16 Ga.
22	532 17 56-07	Rod, Brake	161	872 14 04-06	Bolt Rdhd Sqnk 1/4-20 x 3/4 Gr 5
24	873 35 06-00	Nut	162	873 68 04-00	Nut Crownlock 1/4-20 Unc
25	532 10 68-88	Spring, Rod, Brake	163	874 78 04-16	Bolt Hex Fin 1/4-20 Unc x 1 Gr 5
26	819 13 13-16	Washer 13/32 x 13/16 x 16 Ga.	164	819 09 10-10	Washer 5/8 x .281 x 10 Ga.
27	876 02 04-12	Pin, Cotter 1/8 x 3/4	165	532 16 56-23	Bracket Pivot Lever
28	532 17 57-65	Rod, Parking Brake	166	532 16 68-80	Screw 5/16-18 x 5/8
29	532 07 16-73	Cap, Parking Brake	167	532 16 55-88	Bracket Support Shift CRD
30	532 16 95-92	Bracket, Mfg. Transaxle	168	532 16 54-92	Bolt Shoulder 5/16-18 x .561
34	532 17 55-78	Shaft, Asm Pedal Foot CRD	169	532 16 55-80	Plate Fastening Lt
35	532 12 01-83	Bearing, Nylon	171	817 49 06-08	Screw Thdrol 3/8-16 x 1/2 Ty-Tt
36	819 21 16-16	Washer 21/32 x 1 x 16 Ga.	172	532 17 02-71	Shaft Asm Shifter Frt CRD
37	532 12 49-63	Pin, Roll 3/16 x 1"	177	532 16 59-32	Keeper Flat Idler 3.06" CRD
38	532 16 59-36	Pulley Flat Composite 3.06"	178	532 16 59-33	Keeper Belt Idler 1.88" CRD
39	874 76 06-44	Bolt Fin Hex 3/8-16 Unc x 2-3/4	179	532 12 09-58	Washer Sintered
40	532 12 49-65	Spacer, Split 395 x 59 Bzp	180	532 16 56-30	Pulley, Idler, Flat 1.88" CRD
42	819 13 13-12	Washer 13/32 x 13/16 x 12 Ga.	181	532 18 02-11	Bracket Idler Ground Drive CRD
43	819 11 10-12	Washer 11/32 x 5/8 x 12 Ga.	182	532 16 56-34	Keeper Belt 2.5" Od V-Idler CRD
47	532 12 77-83	Pulley, Idler, V Groove Plasic	183	532 17 90-50	Pulley V-Idler 2.50" Od CRD
48	532 15 44-07	Bellcrank Clutch Grnd Drv	184	817 49 06-44	Screw Hexwsh Thdrol 3/8-16 x 2-3/4
49	532 12 32-05	Retainer, Belt Style Spring	185	532 17 00-08	Link Shift
50	874 76 06-24	Bolt Hex Hd 3/8-16 UNC x 1-1/2	186	532 16 56-14	Hub Tapered Round CRD
51	873 68 06-00	Nut, Crownlock 3/8-16 UNC	187	817 58 05-20	Screw Thdrol 5/16-18 x 1.25
52	873 68 05-00	Nut Crownlock 5/16-18	197	532 16 96-13	Nyliner Snap-In 5/8
53	532 10 57-10	Link, Clutch 7.66	199	532 16 96-12	Bolt Shoulder 5/16-18 Unc
55	532 10 57-09	Spring, Return, Clutch	200	872 14 05-08	Bolt RDHD SQNK 5/16-18 x 1
56	817 06 06-20	Screw 3/8-16 x 1-1/4	202	872 11 06-14	Bolt Carr. Sh. 3/8-16 x 1-3/4 Gr. 5
57	532 17 01-40	V-Belt Kev 112" 0650 CRD	203	871 17 07-80	Bolt Hex 7/16-20 x 5
62	532 12 48-72	Cover, Pedal	207	532 16 98-45	Washer Nylon Rear
65	810 04 07-00	Washer	214	532 17 56-09	Shaft Asm. Brake
66	532 15 47-78	Keeper, Belt Engine F-Proof	215	532 17 56-52	Rod Brake Hydro
71	532 16 91-83	Strap, Torque, Lh	250	817 07 06-12	Screw 3/8-16 x .75
73	532 16 91-82	Strap, Torque, Rh	253	532 17 50-28	Bracket Cable Chassis
74	532 13 70-57	Spacer, Split	254	817 06 06-16	Screw 3/8-16 x 1
75	532 12 17-49	Washer 25/32 x 1-1/4 x 16 Ga.	255	532 17 56-08	Brace Shaft Brake Mtg.
76	812 00 00-01	Ring, E	258	532 17 80-62	Clip Retainer
77	532 12 35-83	Key, Square	259	532 18 02-12	Bracket Pulley
78	532 12 17-48	Washer 25/32 x 1-5/8 x 16 Ga.	261	532 17 34-38	Pulley Idler Flat
81	532 17 00-06	Asm, Shaft	263	817 06 06-12	Screw Thdrol 3/8-16 x 3/4
82	532 16 57-11	Spring, Torsion	264	532 18 19-95	Bracket Clutch Mtg.
83	819 17 12-16	Washer 17/32 x 3/4 x 16 Ga.	265	532 18 20-13	Spacer Idler Chassis
84	532 17 00-07	Link, Transaxle	266	532 18 20-61	Shield Idler
95	532 17 00-15	Control Asm Bypass Hydro	267	872 14 06-24	Bolt RDHD SQNK 3/8-16 x 3
96	532 12 47-88	Spring, Retainer 1"			
120	873 90 06-00	Nut Lock Flg. 3/8-16 Unc			

NOTE: All component dimensions given in U.S. inches
1 inch = 25.4 mm

REPAIR PARTS

TRACTOR- -MODEL NO. M180HCRD (MI180HCRDE), PRODUCT NO. 964 77 29-00
STEERING ASSEMBLY

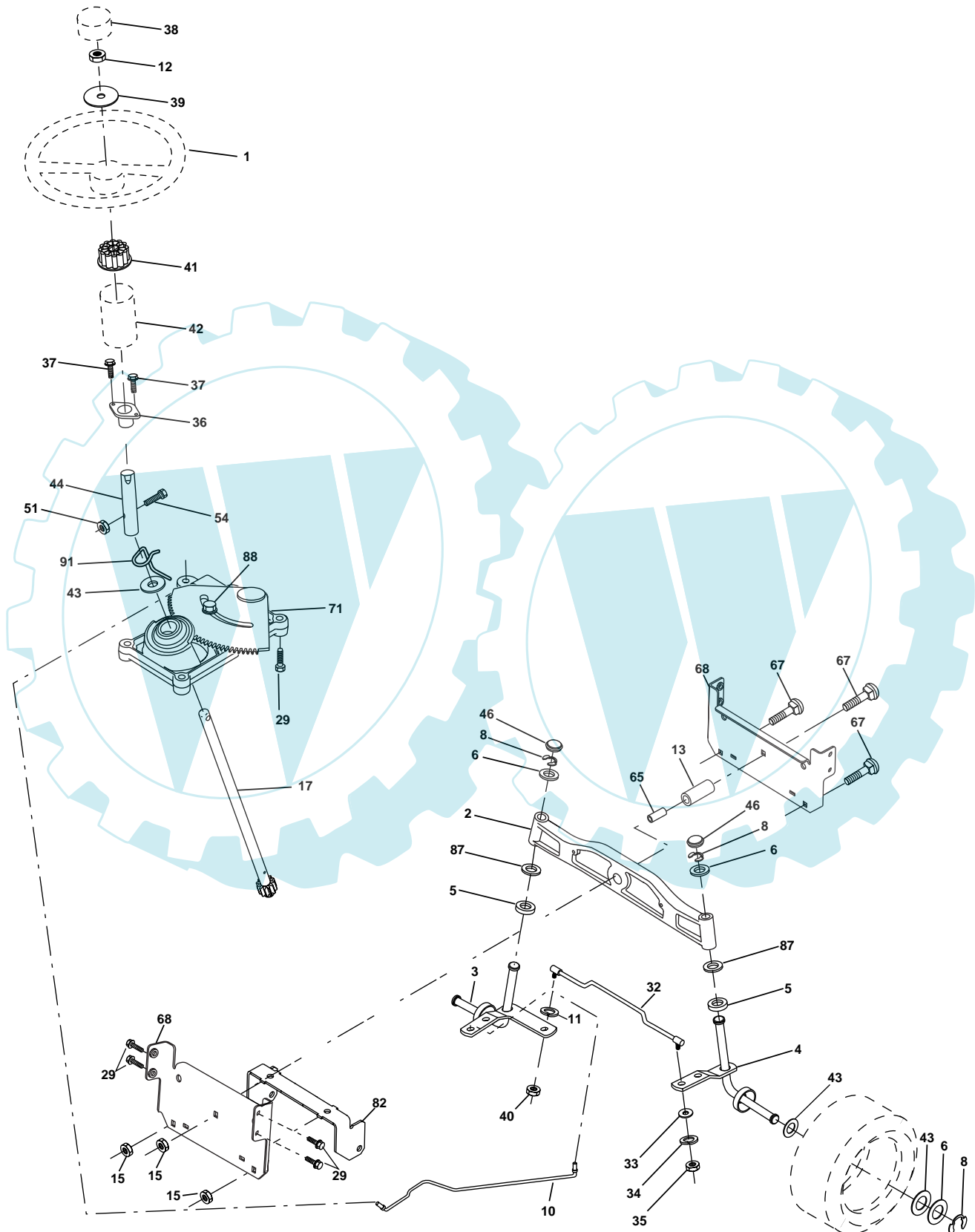

REPAIR PARTS

TRACTOR- -MODEL NO. M180HCRD (M1180HCRDE), PRODUCT NO. 964 77 29-00
STEERING ASSEMBLY

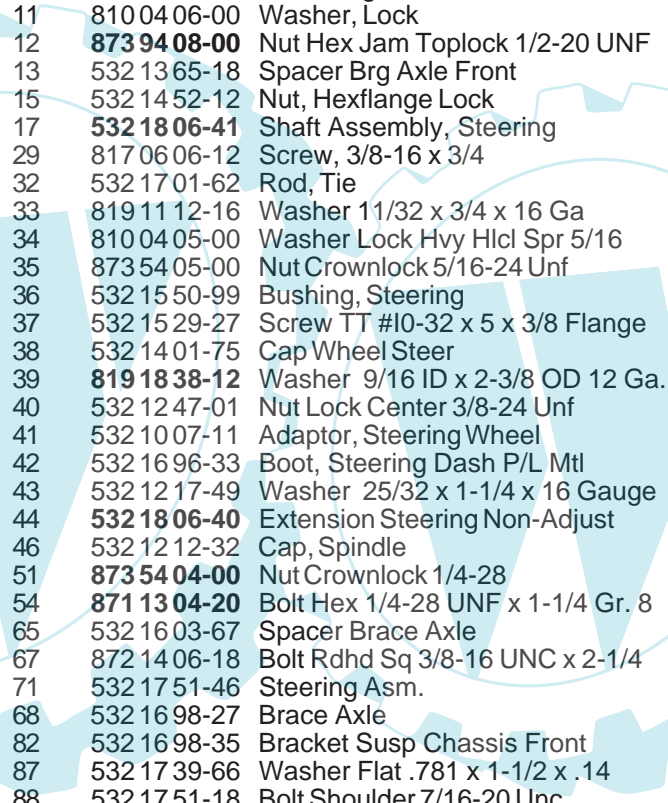

KEY NO.	PART NO.	DESCRIPTION
1	532 1397-68	Steering Wheel
2	532 1723-93	Cast Iron Axle Assembly
3	532 1698-40	Spindle Assembly, L.H.
4	532 1698-39	Spindle Assembly, R.H.
5	532 1249-31	Bearing, Race, Thrust, Hardened
6	532 1217-48	Washer 25/32 x 1-5/8 x 16 Gauge
8	8120000-29	Ring, Klip
10	532 1751-21	Link, Drag
11	8100406-00	Washer, Lock
12	873 94 08-00	Nut Hex Jam Toplock 1/2-20 UNF
13	532 1365-18	Spacer Brg Axle Front
15	532 1452-12	Nut, Hexflange Lock
17	532 1806-41	Shaft Assembly, Steering
29	8170606-12	Screw, 3/8-16 x 3/4
32	532 1701-62	Rod, Tie
33	8191112-16	Washer 11/32 x 3/4 x 16 Ga
34	8100405-00	Washer Lock Hvy Hlcl Spr 5/16
35	8735405-00	Nut Crownlock 5/16-24 Unf
36	532 1550-99	Bushing, Steering
37	532 1529-27	Screw TT #10-32 x 5 x 3/8 Flange
38	532 1401-75	Cap Wheel Steer
39	819 1838-12	Washer 9/16 ID x 2-3/8 OD 12 Ga.
40	532 1247-01	Nut Lock Center 3/8-24 Unf
41	532 1007-11	Adaptor, Steering Wheel
42	532 1696-33	Boot, Steering Dash P/L Mtl
43	532 1217-49	Washer 25/32 x 1-1/4 x 16 Gauge
44	532 1806-40	Extension Steering Non-Adjust
46	532 1212-32	Cap, Spindle
51	873 54 04-00	Nut Crownlock 1/4-28
54	871 13 04-20	Bolt Hex 1/4-28 UNF x 1-1/4 Gr. 8
65	532 1603-67	Spacer Brace Axle
67	872 1406-18	Bolt Rdhd Sq 3/8-16 UNC x 2-1/4
71	532 1751-46	Steering Asm.
68	532 1698-27	Brace Axle
82	532 1698-35	Bracket Susp Chassis Front
87	532 1739-66	Washer Flat .781 x 1-1/2 x .14
88	532 1751-18	Bolt Shoulder 7/16-20 Unc
91	532 1755-53	Clip Steering

NOTE: All component dimensions given in U.S. inches.
1 inch = 25.4 mm.

REPAIR PARTS

TRACTOR- -MODEL NO. M180HCRD (MI180HCRDE), PRODUCT NO. 964 77 29-00
SEAT ASSEMBLY

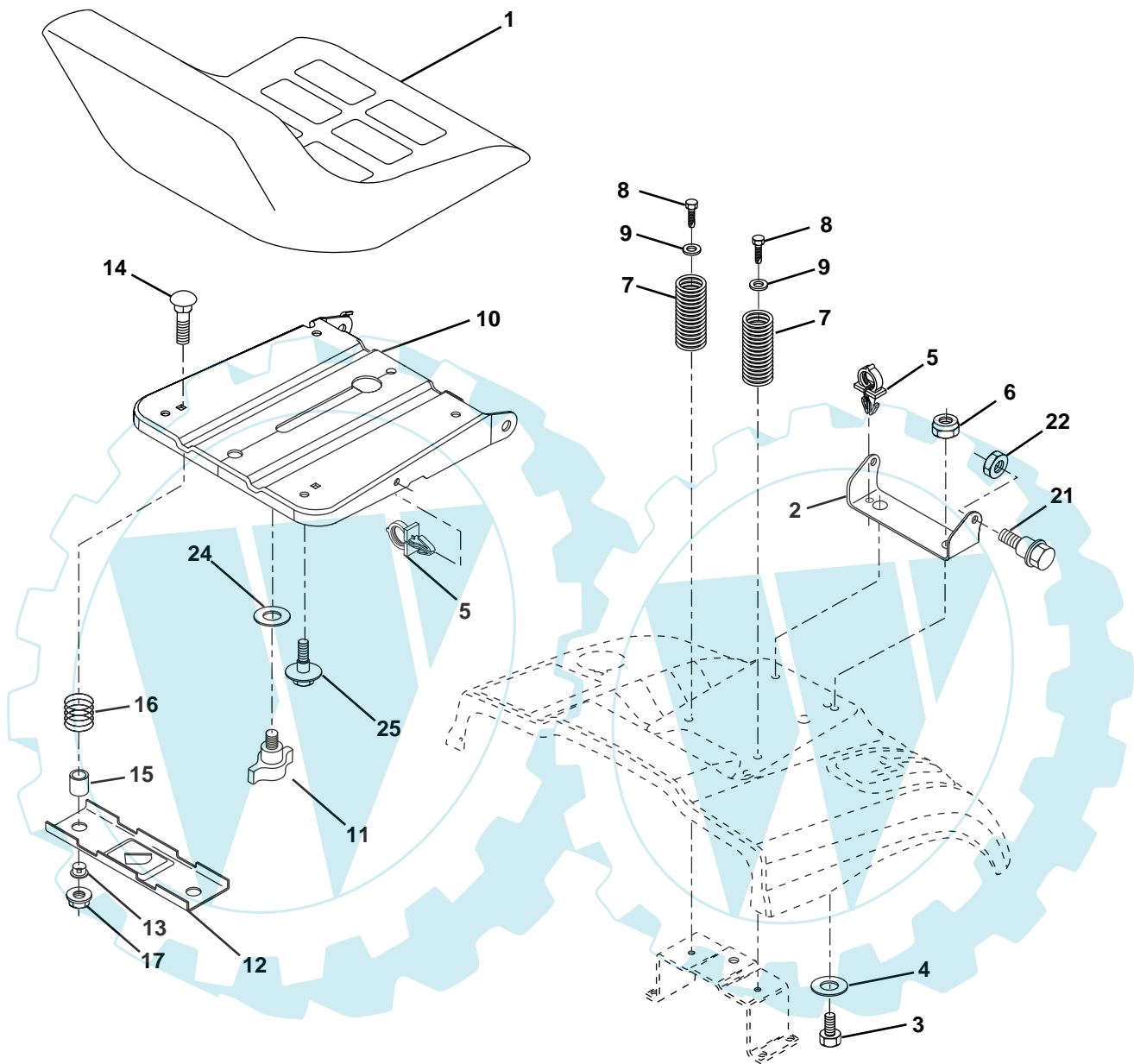

KEY NO.	PART NO.	DESCRIPTION
1	532 14 01-18	Seat
2	532 14 05-51	Bracket Pnt Pivot Seat (blk)
3	871 11 06-16	Bolt Fin Hex 3/8-16 Unc x 1
4	819 13 16-10	Washer Flat 13/32 x 1 x 10 Ga.
5	532 14 50-06	Clip Push In Hinged
6	873 80 06-00	Nut Lock Hex 3/8-16 Unc
7	532 12 41-81	Spring Seat Cprsn 2 250 Blk Zi
8	817 00 06-16	Screw 3/8-16 X 1-1/2
9	819 13 16-14	Washer 13/32 X 1 X 14 Ga
10	532 17 48-94	Pan Pnt Seat (blk)
11	532 16 63-69	Knob Seat Adj Wingnut
12	532 12 12-46	Bracket Pnt Mounting Switch

KEY NO.	PART NO.	DESCRIPTION
13	532 12 12-48	Bushing Snap Blk Nyl 50 Id
14	872 05 04-12	Bolt Rdhd Sht Nk 1/4-20x1-1/2
15	532 12 12-49	Spacer Split
16	532 12 37-40	Spring Cprsn Plate SW 1.310 Ga
17	532 12 39-76	Nut Lock 1/4 Lge Flg Gr 5 Zinc
21	532 17 18-52	Bolt Shoulder 5/16-18 Unc-2A
22	873 80 05-00	Nut Hex Lock w/Ins 5/16-18
24	819 17 19-12	Washer 17/32 X 1-3/16 X 12 Ga.
25	532 12 70-18	Bolt Shoulder 5/16-18 X 62

NOTE: All component dimensions given in U.S. inches.
1 inch = 25.4 mm

REPAIR PARTS

TRACTOR- -MODEL NO. M180HCRD (MI180HCRDE), PRODUCT NO. 964 77 29-00
DECALS

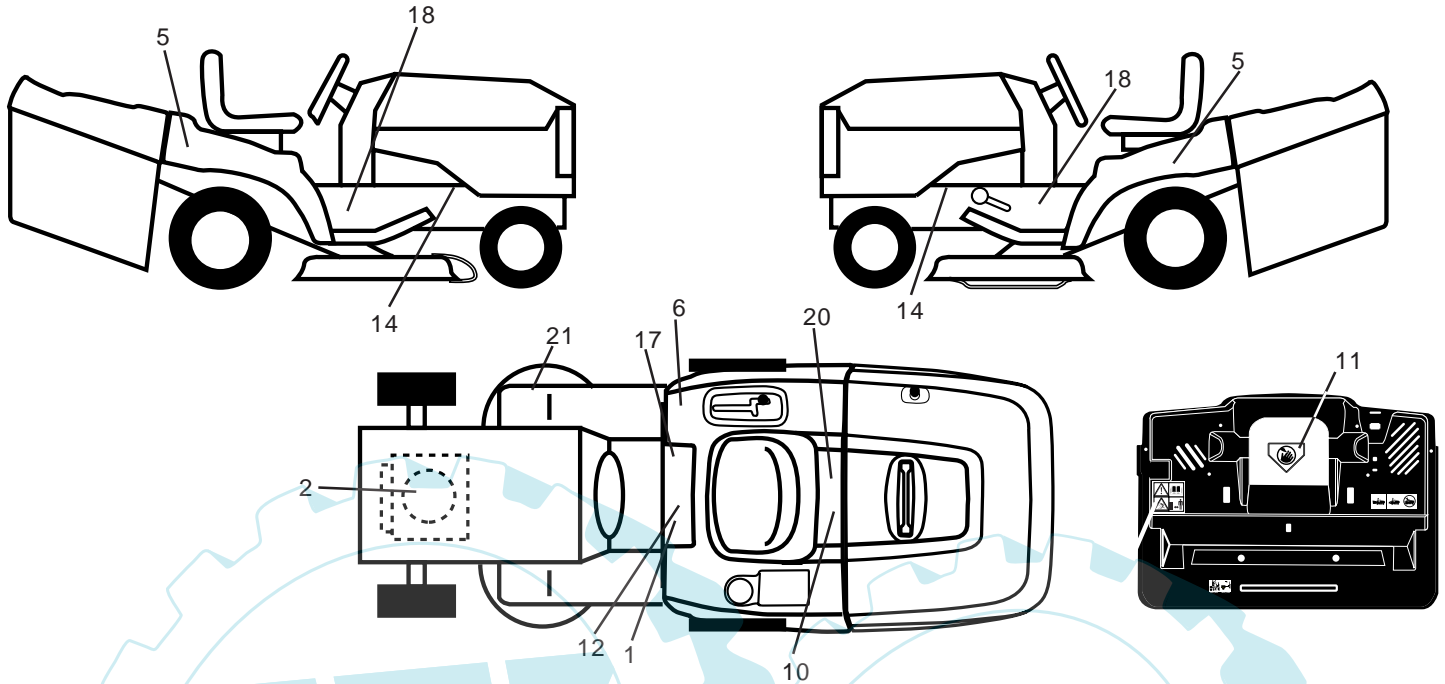

KEY NO.	PART NO.	DESCRIPTION
1	532 14 54-98	Decal Read Owner's Manual Sym
2	532 18 07-07	Decal Hp Engine
5	532 14 09-50	Decal Fender Automatic
6	532 18 04-32	Decal 100 DB/CE
10	532 14 50-05	Decal Bat Dan/Poi P/L Sym Wpn
11	532 18 21-66	Decal Mower Cut Finger Symbol
12	532 15 97-37	Decal Brake/Clutch Symbol Lt
14	532 15 97-36	Decal Chassis Hot Muffler
17	532 14 08-37	Decal Saddle Brake Parking
18	532 13 75-88	Decal Chas Turbo

KEY NO.	PART NO.	DESCRIPTION
20	532 16 69-60	Decal Bypass Fender CRD
21	532 16 62-86	Decal Hex Belt Sch
—	532 13 83-11	Decal Lift Handle
—	532 18 10-90	Pad Footrest RH
—	532 18 01-91	Pad Footrest LH
—	532 18 04-35	Decal Rear Plate CRD Symbol
—	532 18 26-21	Decal Bagger Fram Asy.
—	532 18 31-27	Manual Operator's (Euro)
—	532 18 31-31	Manual Parts

WHEELS & TIRES

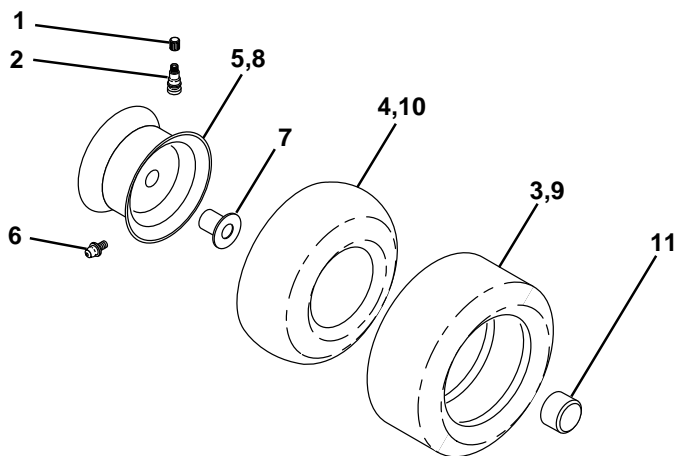

KEY NO.	PART NO.	DESCRIPTION
1	532 05 91-92	Cap Value Tire
2	532 06 51-39	Stem Value
3	532 10 62-22	Tire F Ts 15 X 6 0 - 6 Service
4	532 05 99-04	Tube Inner Front #35060
5	532 12 51-21	Rim Asm 6" front Service
6	532 12 49-57	Fitting Grease
7	532 12 49-59	Bearing Flange
8	532 12 51-22	Rim Asm 8" rear Service
9	532 13 84-68	Tire R Ts 20 x 8-8 Service
10	532 12 49-26	Tube Rear 9 5 X 8 Service
11	532 17 50-39	Cap Axle Blk 1 50 X 1 00
--	532 14 43-34	Sealant, Tire (10 oz. tube)

NOTE: All component dimensions given in U.S. inches
1 inch = 25.4 mm

REPAIR PARTS

TRACTOR- -MODEL NO. M180HCRD (M1180HCRDE), PRODUCT NO. 964 77 29-00
ENGINE

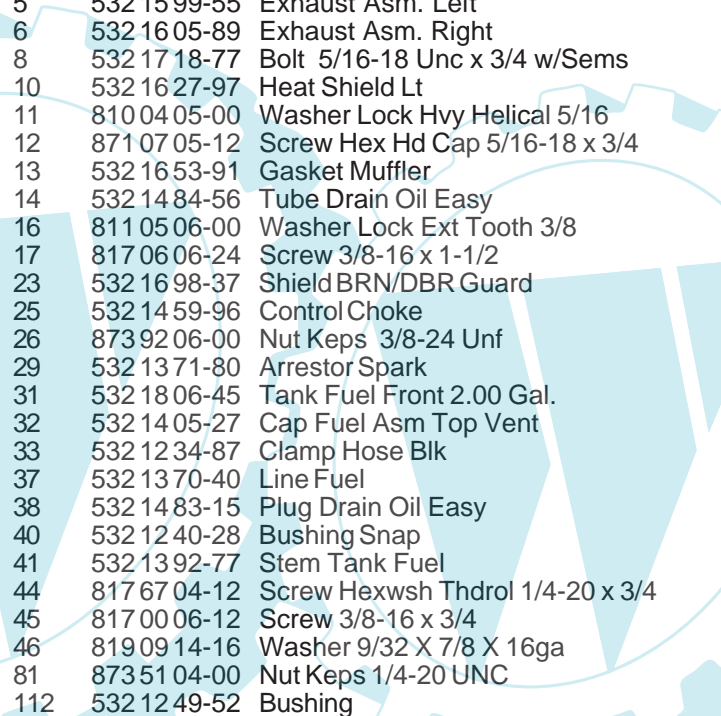

KEY NO.	PART NO.	DESCRIPTION
1	532 17 07-71	Control Throt Flag
2	817 72 04-08	Screw Hex Thd Cut 1/4-20x1/2
3	-----	Engine B&S Model 407777 (Order Parts from Engine Manufacturer)
4	532 14 97-23	Muffler Exhaust
5	532 15 99-55	Exhaust Asm. Left
6	532 16 05-89	Exhaust Asm. Right
8	532 17 18-77	Bolt 5/16-18 Unc x 3/4 w/Sems
10	532 16 27-97	Heat Shield Lt
11	810 04 05-00	Washer Lock Hvy Helical 5/16
12	871 07 05-12	Screw Hex Hd Cap 5/16-18 x 3/4
13	532 16 53-91	Gasket Muffler
14	532 14 84-56	Tube Drain Oil Easy
16	811 05 06-00	Washer Lock Ext Tooth 3/8
17	817 06 06-24	Screw 3/8-16 x 1-1/2
23	532 16 98-37	Shield BRN/DBR Guard
25	532 14 59-96	Control Choke
26	873 92 06-00	Nut Keps 3/8-24 Unf
29	532 13 71-80	Arrestor Spark
31	532 18 06-45	Tank Fuel Front 2.00 Gal.
32	532 14 05-27	Cap Fuel Asm Top Vent
33	532 12 34-87	Clamp Hose Blk
37	532 13 70-40	Line Fuel
38	532 14 83-15	Plug Drain Oil Easy
40	532 12 40-28	Bushing Snap
41	532 13 92-77	Stem Tank Fuel
44	817 67 04-12	Screw Hexwsh Thdrol 1/4-20 x 3/4
45	817 00 06-12	Screw 3/8-16 x 3/4
46	819 09 14-16	Washer 9/32 X 7/8 X 16ga
81	873 51 04-00	Nut Keps 1/4-20 UNC
112	532 12 49-52	Bushing

NOTE: All component dimensions given in U.S. inches
1 inch = 25.4 mm

REPAIR PARTS

TRACTOR- -MODEL NO. M180HCRD (MI180HCRDE), PRODUCT NO. 964 77 29-00
MOWER LIFT

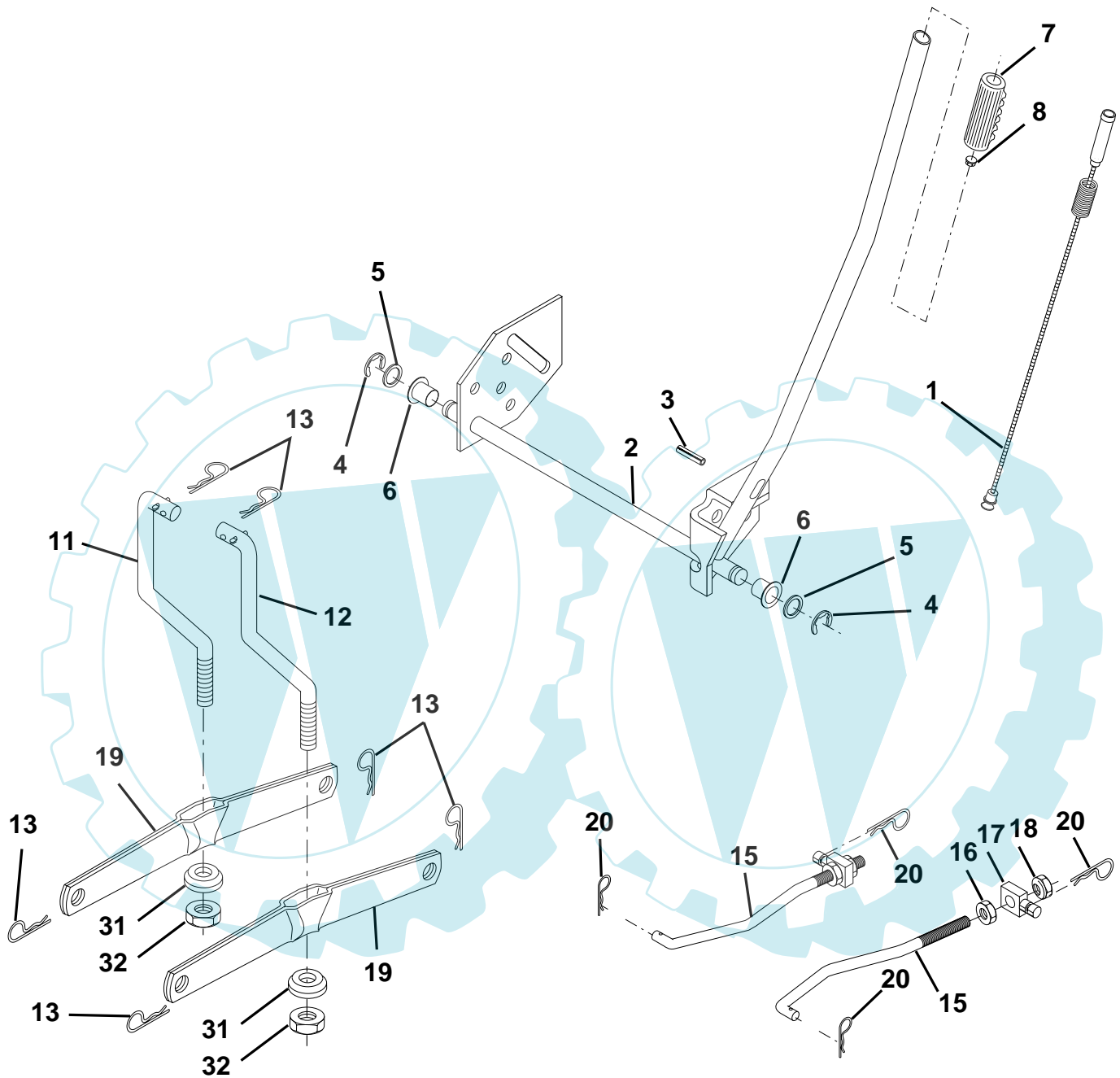

REPAIR PARTS

TRACTOR- -MODEL NO. M180HCRD (M180HCRDE), PRODUCT NO. 964 77 29-00
MOWER LIFT

KEY NO.	PART NO.	DESCRIPTION
1	532 15 94-60	Washer Asm Inner Spring W/Plunger
2	532 15 94-71	Shaft Asm. Lift
3	532 10 57-67	Pin Groove
4	812 00 00-02	E Ring #5133-62
5	819 21 16-21	Washer 21/32 x 1 x 21 Ga.
6	532 12 01-83	Bearing Nylon
7	532 10 94-13	Grip Handle Bicycle
8	532 12 45-26	Button Plunger Black
11	532 16 58-29	Link Asm Lift L.H.
12	532 16 58-31	Link Asm Lift R.H.
13	532 12 46-70	Retainer Spring
15	532 17 32-88	Link Front
16	873 35 08-00	Nut Jam Hex 1/2-13 Unc
17	532 17 56-89	Trunnion
18	873 80 08-00	Nut Lock w/Wsh 1/2-13 Unc
19	532 13 98-68	Arm Suspension Mower
20	532 16 35-52	Retainer Spring
31	532 16 98-65	Bearing, Pvt. Lift
32	873 54 06-00	Nut Crownlock 3/8-24

NOTE: All component dimensions given in U.S. inches
1 inch = 25.4 mm

REPAIR PARTS

TRACTOR- -MODEL NO. M180HCRD (MI180HCRDE), PRODUCT NO. 964 77 29-00
MOWER

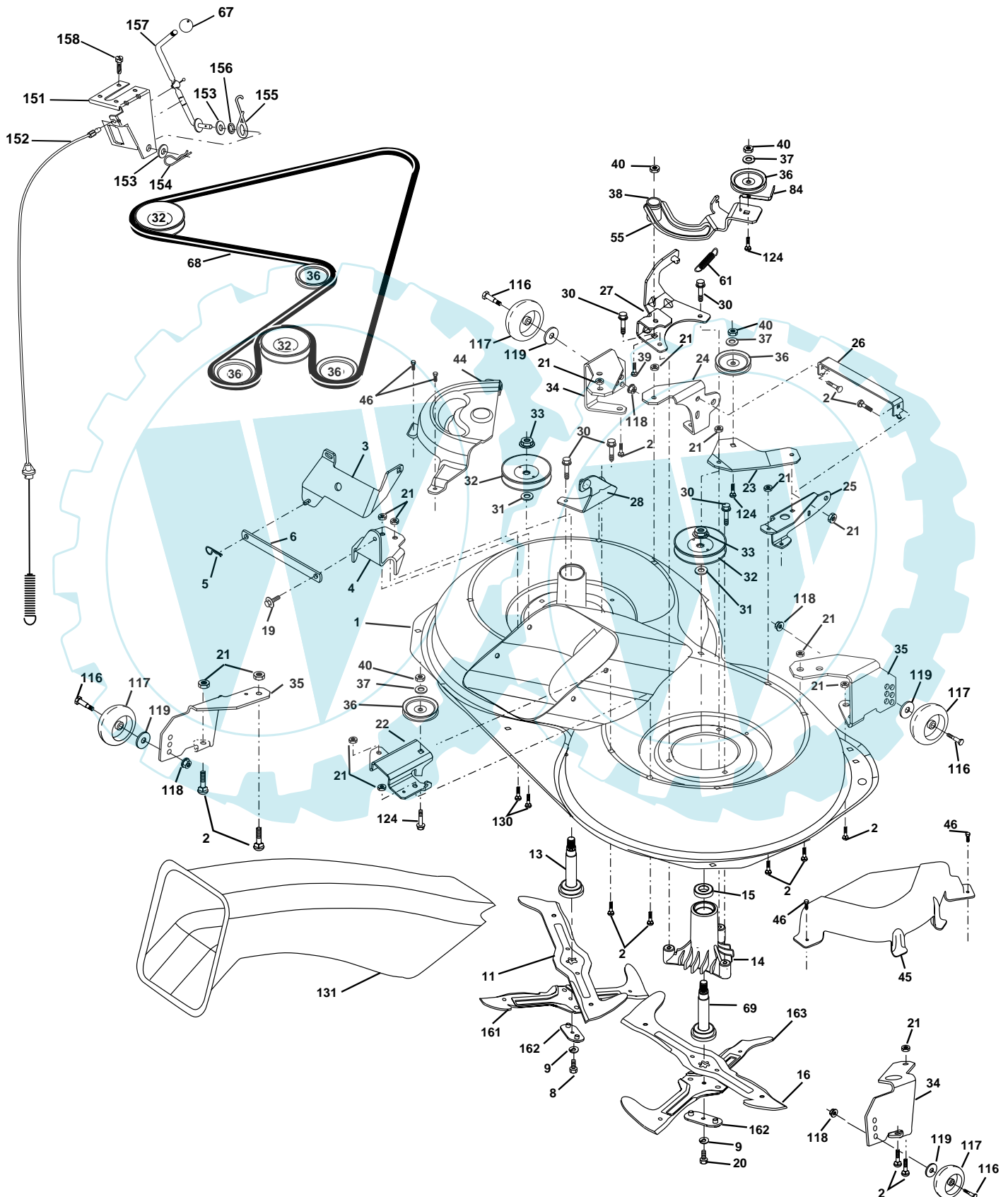

REPAIR PARTS

TRACTOR- -MODEL NO. M180HCRD (M180HCRDE), PRODUCT NO. 964 77 29-00
MOWER

KEY NO.	PART NO.	DESCRIPTION	KEY NO.	PART NO.	DESCRIPTION
1	532 1691-60	Housing Asm. Mower	44	532 17 55-38	Cover Mandrel Lh
2	872 1405-06	Bolt Rdhd Sqnk 5/16-18 Unc x 3/4	45	532 17 55-39	Cover Mandrel Rh
3	532 1655-69	Bracket Asm. S-Bar Chass	46	532 13 77-29	Screw Thd Roll 1/4-20 x 5/8
4	532 1691-67	Bracket Bar Sway Deck	55	532 16 98-49	Arm Idler 107 CRD
5	532 1246-70	Retainer Spring	61	532 17 51-59	Spring Tension Belt
6	532 1655-57	Bar Sway	67	532 10 69-32	Knob Rd 3/8-16 Plstc Thds Blk
8	532 18 17-12	Bolt 3/8-24 x 1.25 Gr8 Patched	68	532 16 91-78	Hex-Belt Mower
9	810 0306-00	Washer Lock Hvy 3/8 Unplated	69	532 16 54-82	Shaft Asm W/Lwr Brg Rh Thd CRD
11	532 1805-83	Blade 3-1 Lh	84	532 15 60-85	Keeper Belt Idler
13	532 1376-45	Shaft Asm. W/Lower Bearing	116	532 13 76-44	Bolt Shoulder
14	532 1287-74	Housing Mandrel Vented (Machd)	117	532 13 39-57	Wheel Gage Donut Wide
15	532 11 04-85	Bearing Ball Mandrel	118	873 93 06-00	Nut Centerlock 3/8-16 Unc
16	532 1805-84	Blade 3-1 Rh	119	819 12 14-14	Washer 3/8 x 7/8 x 14 Ga.
19	532 1328-27	Bolt Shoulder 5/16-18 Thd Form	124	872 11 06-12	Bolt Carr Sh 3/8-16 x 1-1/2 Gr5
20	532 18 17-13	Bolt 3/8-24 x 1.25 Gr8 Ptch Lhthd	130	872 11 05-06	Bolt Rdhdsqnk 5/16-18 Unc x 3/4
21	873 68 05-00	Nut Crown Lock 5/16-18	131	532 16 56-61	Chute Bagger CRD 92cm
22	532 1691-65	Bracket Idler RR	151	532 16 96-70	Bracket Clutch Cable
23	532 1691-66	Bracket Idler RF	152	532 17 60-74	Cable Clutch CRD Service
24	532 1691-70	Bracket Suspension LF	153	532 16 96-74	Washer Flat 3/8" Type B
25	532 1691-71	Bracket Suspension RF	154	532 16 96-75	Spring Retainer
26	532 1652-37	Brace Support Susp Frt CRD	155	532 16 96-71	Spring Retainer Lvr Cltch Cab
27	532 1691-72	Bracket Asm. Susp RR	156	532 16 96-72	Spacer Clutch Cable
28	532 1691-68	Bracket Asm. Susp LR	157	532 16 96-69	Rod Clutch Cable 3/8"
30	532 17 39-84	Screw Thd Rolling	158	817 72 04-08	Screw Hex Thdcut 1/4-20 x 1/2
31	532 12 99-63	Washer Spacer Mower Vented	161	532 18 04-24	Blade Cross LH
32	532 17 57-07	Mandrel Pulleys	162	532 18 08-78	Adapter Weldment
33	532 17 83-42	Nut Flg Top Lock	163	532 18 04-25	Blade Cross RH
34	532 17 95-09	Bracket Gauge Wheel Lf	-	532 18 18-57	Mandrel Asm Service
35	532 17 62-92	Bracket Gauge Wheel Rf	-	532 18 18-58	Mandrel Asm CRD Lh Threads SVC
36	532 14 67-63	Pulley Idler V-Groove Dim 4.25	-	532 18 17-70	Deck Mower Complete
37	819 13 13-16	Washer 11/32 x 13/16 x 16 Ga			
38	532 16 98-51	Spacer Hub Arm Idler 107 CRD			
39	872 11 06-22	Bolt Rdhd 3/8-16 Unc x 2-3/4 Gr. 5			
40	873 68 06-00	Nut Crownlock 3/8-16 Unc			

NOTE: All component dimensions given in U.S. inches
1 inch = 25.4 mm

REPAIR PARTS

TRACTOR- -MODEL NO. M180HCRD (MI180HCRDE), PRODUCT NO. 964 77 29-00
BAGGER

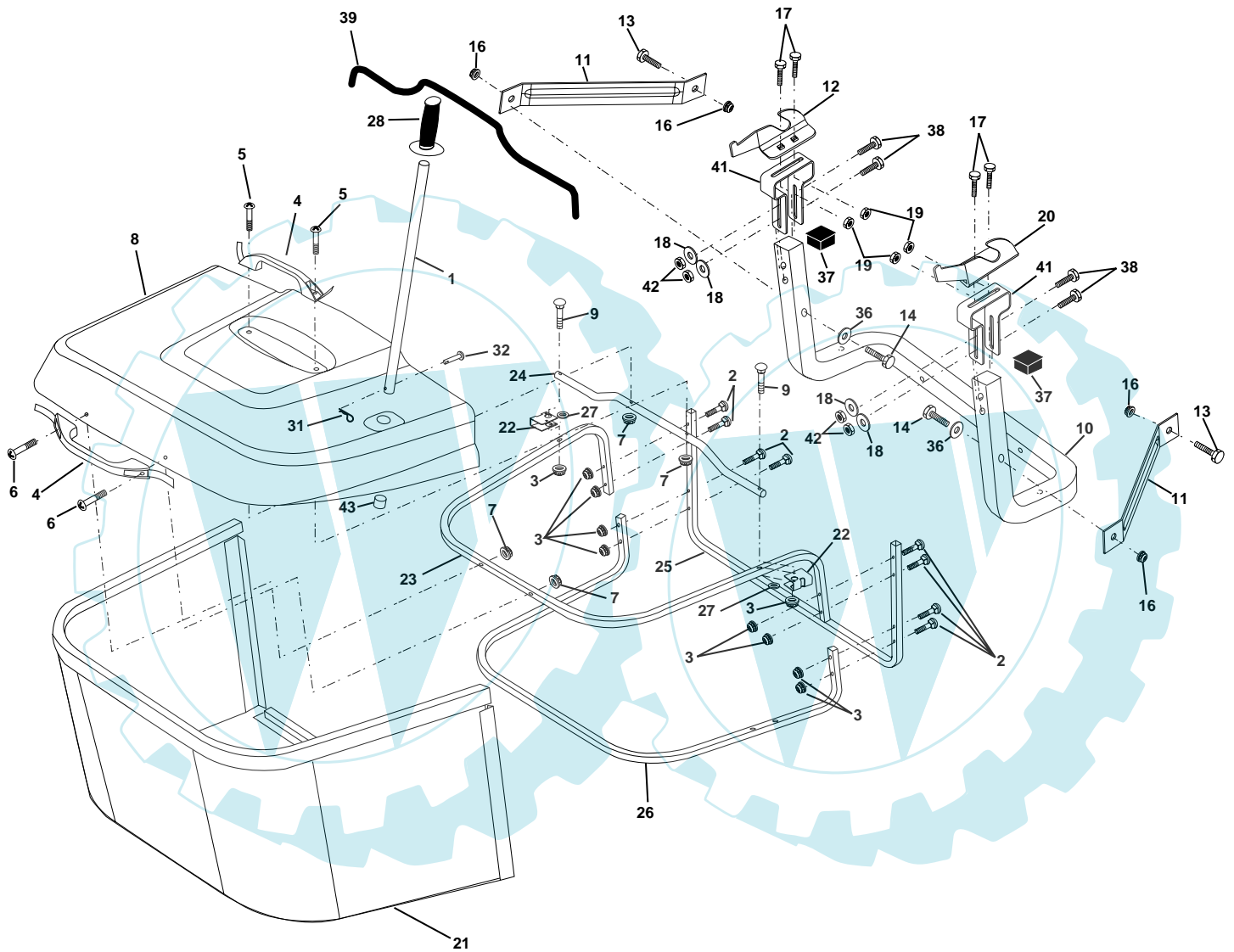

REPAIR PARTS

TRACTOR- -MODEL NO. M180HCRD (M180HCRDE), PRODUCT NO. 964 77 29-00
BAGGER

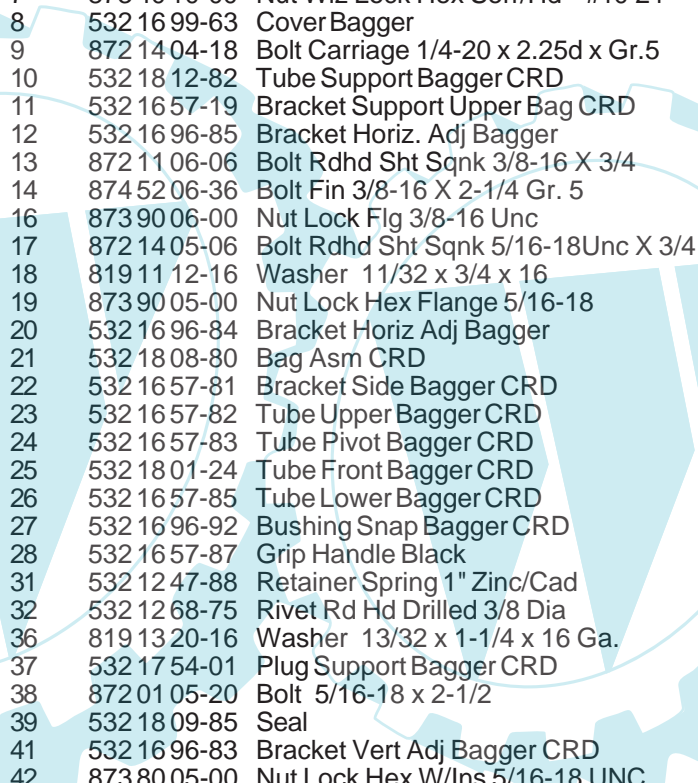

KEY NO.	PART NO.	DESCRIPTION
1	532 16 52-49	Tube Handle Bagger CRD
2	872 14 04-16	Bolt Carriage 1/4-20 X 2.0 Gr.5
3	532 12 39-76	Nut Lock 1/4 Lge Flg Gr. 5 Zinc
4	532 16 99-16	Handle Bagger w/Lvrs Gr. 5 Zinc
5	874 98 10-24	Screw Pan Head #10-24 X 1.50 Blk
6	874 98 10-32	Screw Pan Hd
7	873 40 10-00	Nut Wiz Lock Hex Serr/Hd #10-24
8	532 16 99-63	Cover Bagger
9	872 14 04-18	Bolt Carriage 1/4-20 x 2.25d x Gr.5
10	532 18 12-82	Tube Support Bagger CRD
11	532 16 57-19	Bracket Support Upper Bag CRD
12	532 16 96-85	Bracket Horiz. Adj Bagger
13	872 11 06-06	Bolt Rdhd Sht Sqnk 3/8-16 X 3/4
14	874 52 06-36	Bolt Fin 3/8-16 X 2-1/4 Gr. 5
16	873 90 06-00	Nut Lock Flg 3/8-16 Unc
17	872 14 05-06	Bolt Rdhd Sht Sqnk 5/16-18Unc X 3/4
18	819 11 12-16	Washer 11/32 x 3/4 x 16
19	873 90 05-00	Nut Lock Hex Flange 5/16-18
20	532 16 96-84	Bracket Horiz Adj Bagger
21	532 18 08-80	Bag Asm CRD
22	532 16 57-81	Bracket Side Bagger CRD
23	532 16 57-82	Tube Upper Bagger CRD
24	532 16 57-83	Tube Pivot Bagger CRD
25	532 18 01-24	Tube Front Bagger CRD
26	532 16 57-85	Tube Lower Bagger CRD
27	532 16 96-92	Bushing Snap Bagger CRD
28	532 16 57-87	Grip Handle Black
31	532 12 47-88	Retainer Spring 1" Zinc/Cad
32	532 12 68-75	Rivet Rd Hd Drilled 3/8 Dia
36	819 13 20-16	Washer 13/32 x 1-1/4 x 16 Ga.
37	532 17 54-01	Plug Support Bagger CRD
38	872 01 05-20	Bolt 5/16-18 x 2-1/2
39	532 18 09-85	Seal
41	532 16 96-83	Bracket Vert Adj Bagger CRD
42	873 80 05-00	Nut Lock Hex W/Ins 5/16-18 UNC

NOTE: All component dimensions given in U.S. inches
1 inch = 25.4 mm

SERVICE NOTES

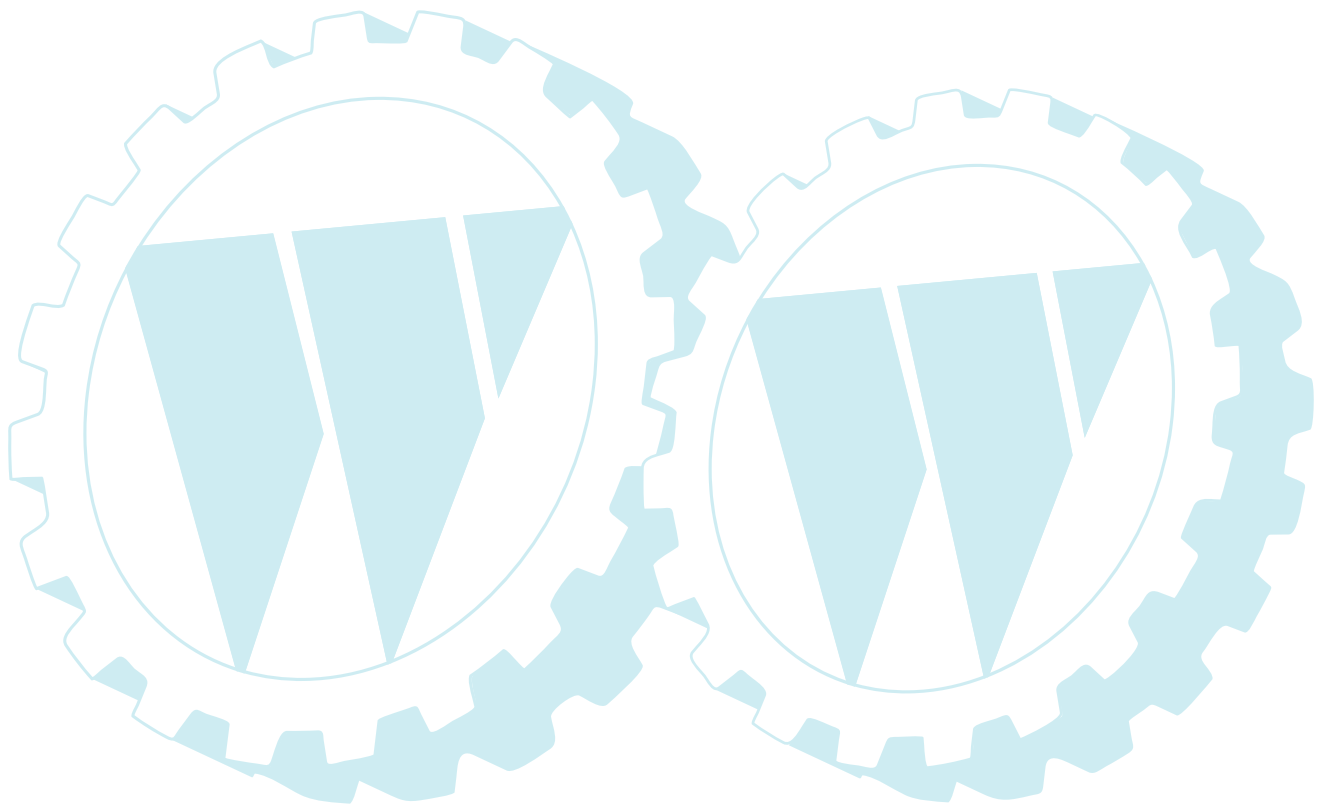

SERVICE NOTES

